

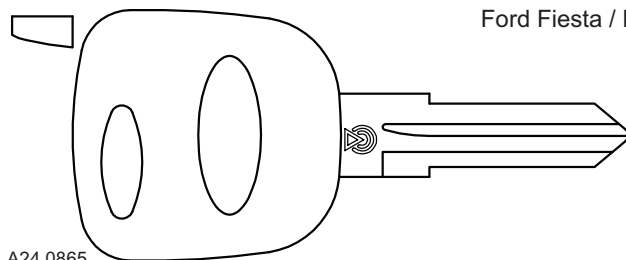

chaves e fechaduras



Ford Fiesta / Ecosport

A24.0865

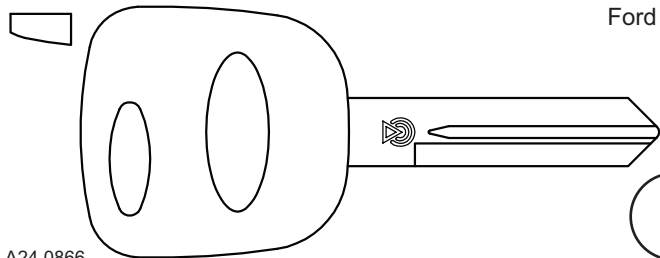

Ford F250

A24.0866

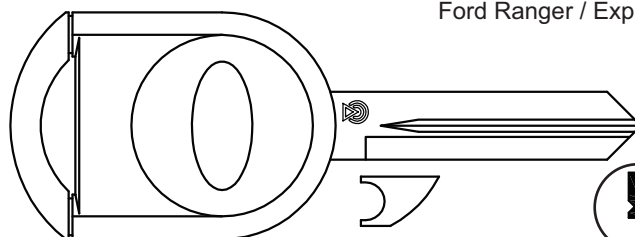

Ford Ranger / Explorer

A24.0875

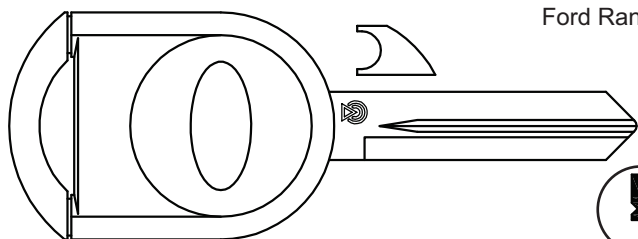

Ford Ranger

A24.0991



chaves e fechaduras

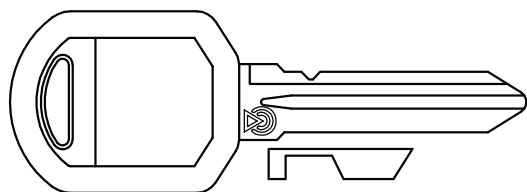

GM S-10 / Blazer

A24.0867

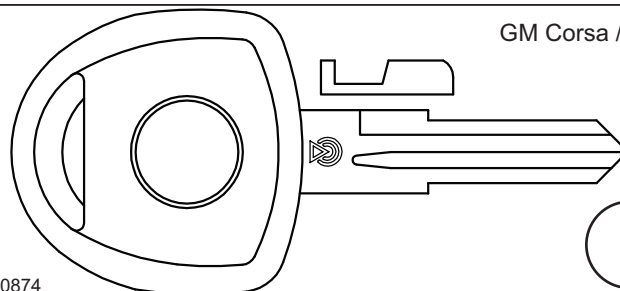

GM Corsa / Astra

A24.0874

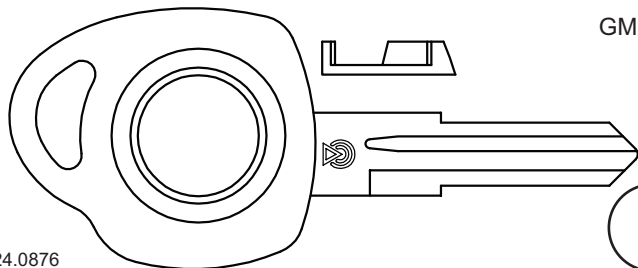

GM Celta

A24.0876

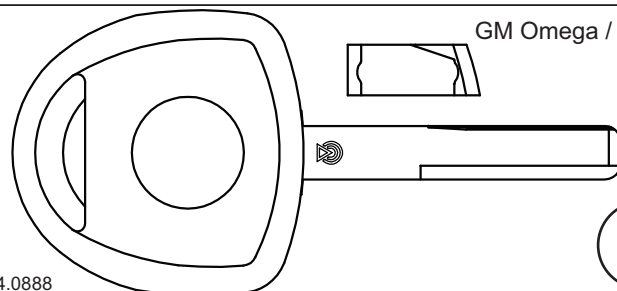

GM Omega / Vectra

A24.0888

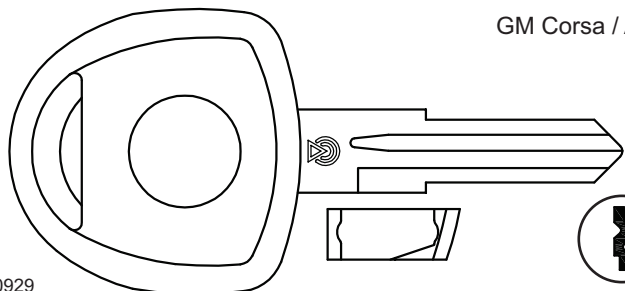

GM Corsa / Astra

A24.0929

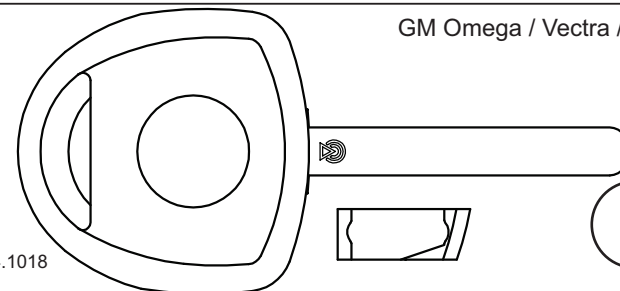

GM Omega / Vectra / Agile









A24.1018

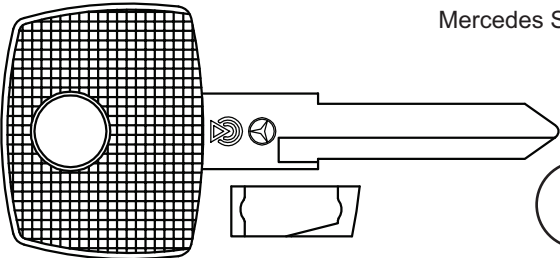
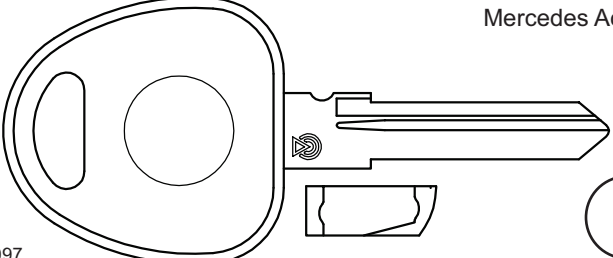

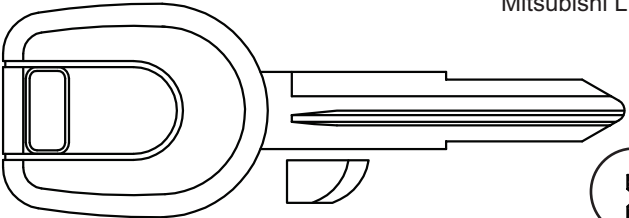
chaves e fechaduras

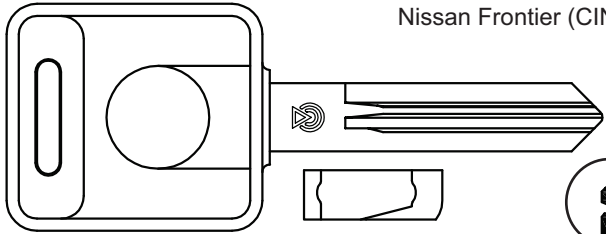
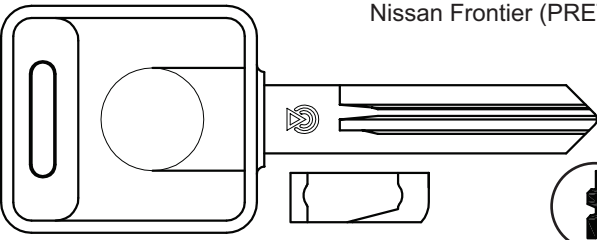

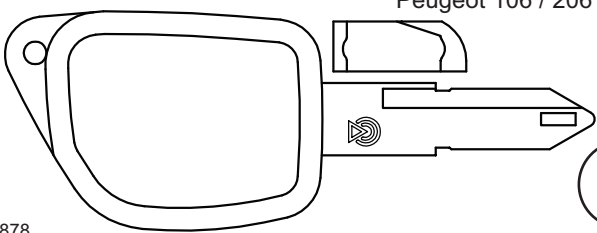
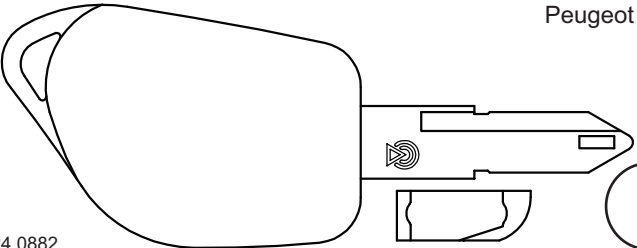
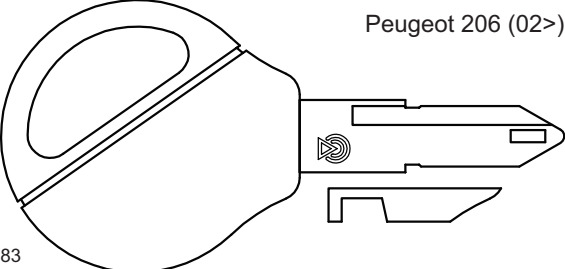
chaves e fechaduras

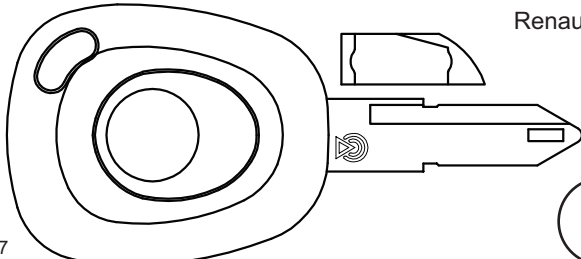
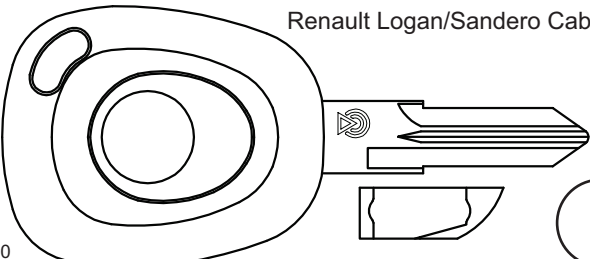
<p>Mercedes Sprinter</p>  <p>A24.0942</p>	<p>Mercedes Accelo</p>  <p>A24.1097</p>
 <p>chaves e fechaduras</p>	<p>Mitsubishi L 200</p>  <p>A24.0997</p>
 <p>chaves e fechaduras</p>	<p>Nissan Frontier (CINZA)</p>  <p>A24.1050</p>
<p>Nissan Frontier (PRETA)</p>  <p>A24.1165</p>	 <p>chaves e fechaduras</p>
<p>Peugeot 106 / 206 - 2003</p>  <p>A24.0878</p>	<p>Peugeot 2002</p>  <p>A24.0882</p>
<p>Peugeot 206 (02&gt;) Multiplex</p>  <p>A24.0883</p>	 <p>chaves e fechaduras</p>
<p>Renault Clio</p>  <p>A24.0877</p>	<p>Renault Logan/Sandero Cab. Clio.</p>  <p>A24.1150</p>

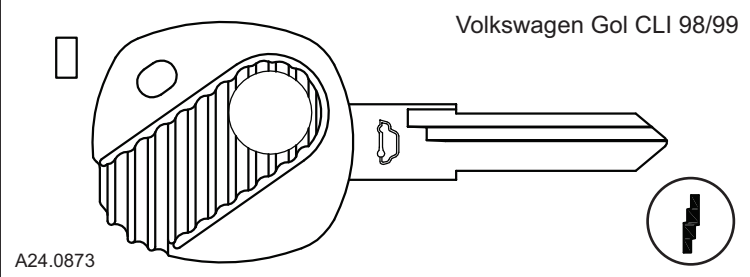
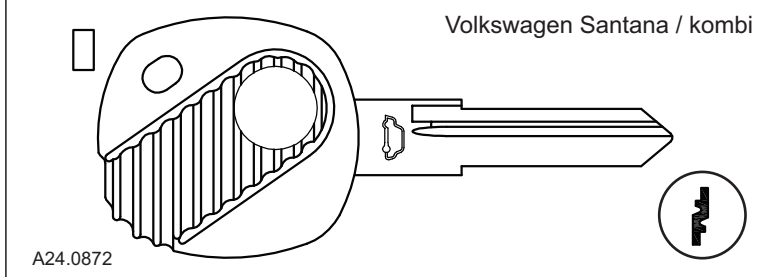
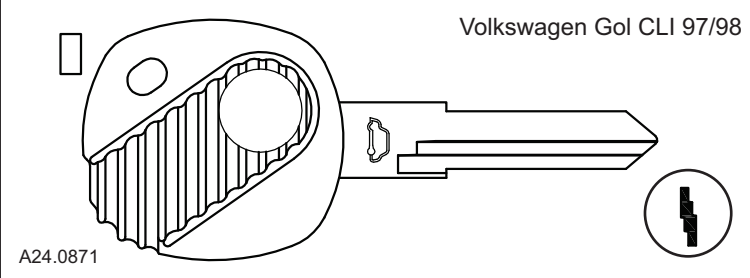
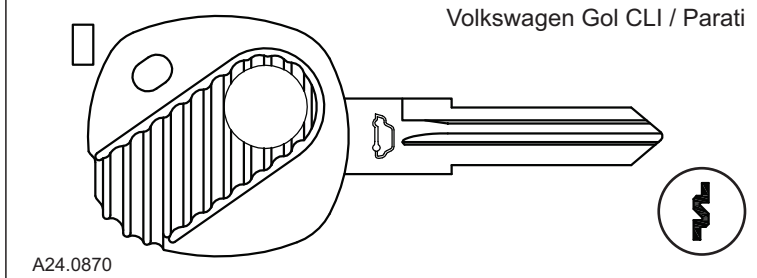
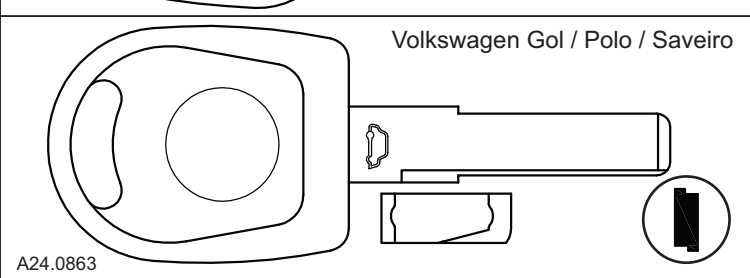
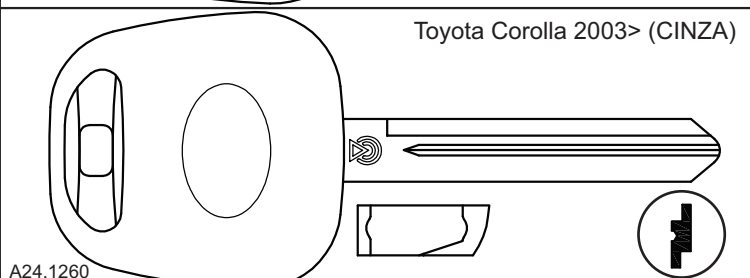
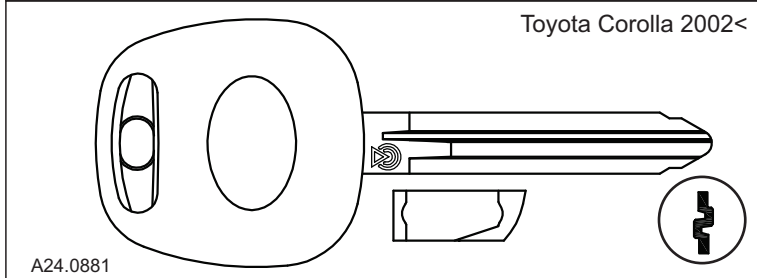
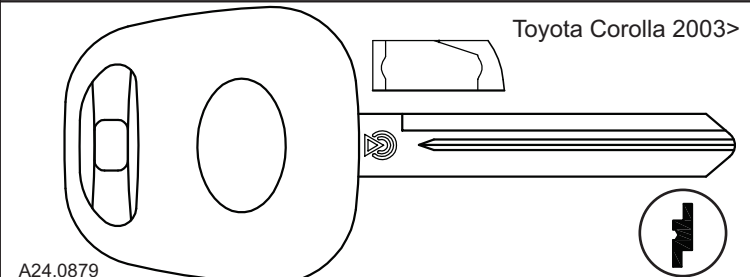
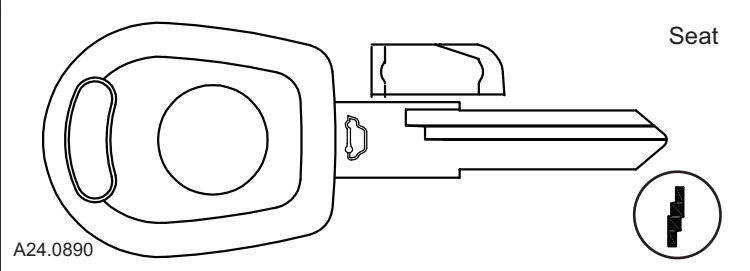
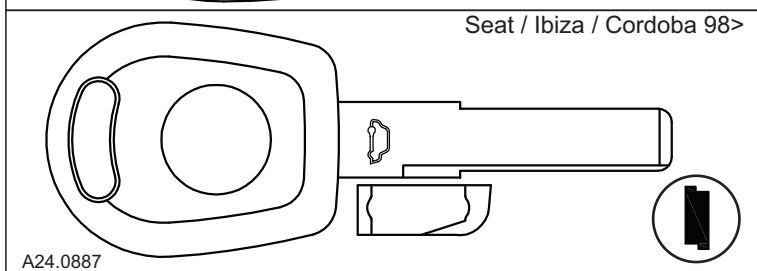
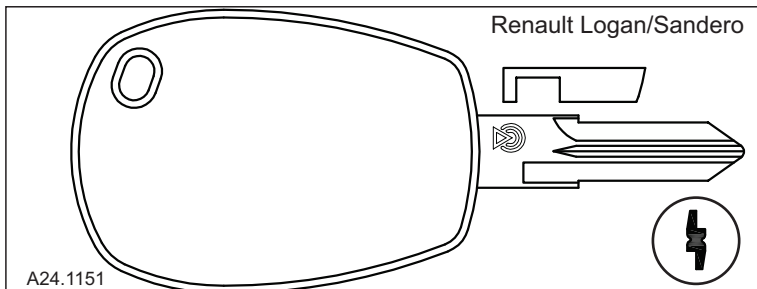

Volkswagen Golf (Escada)

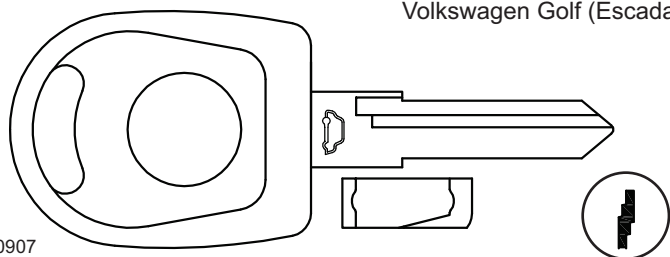

A24.0907

